

**clarion**

**APA5241**

**5-CHANNEL**

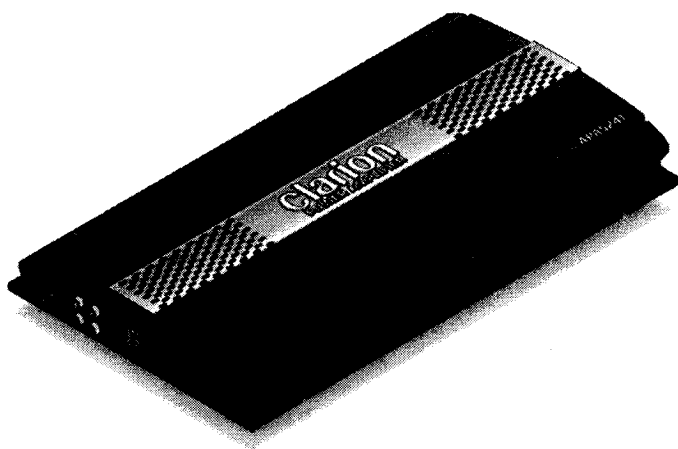

**CAR AUDIO  
AMPLIFIER**

**OPERATION  
INSTALLATION  
MANUAL**

# INTRODUCTION

Thank you for purchasing a Clarion APA5241 5-channel car audio amplifier. You've selected an amplifier that is one of the finest and most unique available on the market today. For 4-ohm loads, the APA5241 puts out 35 watts of continuous power on channels 1 through 4 and also delivers 100 watts of continuous power on channel 5. It also comes with the following features:

- ◆ Full frequency response with low distortion and exceptional signal-to-noise performance
- ◆ Advanced circuit design features bridgeable and mixed-mode operation for use in a variety of 5-, 4-, or 3-channel systems, including those with satellite speakers and subwoofers
- ◆ Four high-pass and one low-pass, 12 dB-per-octave, electronic crossovers (selectable at 80, 120, or 180 Hz ) to aid in audio system design
- ◆ Variable-gain bass extender circuit (on channel 5) to reinforce 45 Hz signals that may be lost due to box design
- ◆ Ground loop isolation inputs with adjustable input level controls to accept a wide range of input signals (from 200 mV to 5 V for RCA inputs or 400 mV to 10 V for speaker-level inputs)
- ◆ Remote turn-on with "soft-start" muting to prevent turn-on "thump"
- ◆ Regulated MOSFET power supply with low AM RFI and protection circuits for overheating and speaker shorts
- ◆ 2-ohm load capability to drive a variety of speaker systems
- ◆ Gold-plated input/output connectors and an external automotive-type fuse
- ◆ Aluminum heat sinks with an integrated cooling fan for efficient dissipation of heat

In order to start enjoying your new Clarion APA5241 5-channel car audio amplifier as soon as possible, please read the remaining pages to plan your installation. When you're finished, fill out and send in the enclosed warranty card to protect your purchase and to aid us in any service-related questions. Also, **save your original bill of sale as a proof of purchase.**

# TABLE OF CONTENTS

<b>Description</b> .....	<b>3</b>
<b>Amplifier Inputs/Controls/Power Indicator</b> .....	<b>4</b>
<b>2-, 3-, 4-Channel Input Configurations</b> .....	<b>6</b>
<b>Connections for Speakers/Power</b> .....	<b>7</b>
<b>Applications</b> .....	<b>8</b>
<b>5-Ch. Full-Range System with Subwoofer(s)</b> .....	<b>8</b>
<b>5-Ch. Satellite System with Subwoofer(s)</b> .....	<b>9</b>
<b>3-Ch. Full-Range System with Subwoofer(s)</b> .....	<b>10</b>
<b>3-Ch. Satellite System with Subwoofer(s)</b> .....	<b>11</b>
<b>Installation</b> .....	<b>12</b>
<b>Mounting Precautions</b> .....	<b>12</b>
<b>Wiring Precautions</b> .....	<b>12</b>
<b>Setting Gain</b> .....	<b>15</b>
<b>Using The HP/LP Filter</b> .....	<b>16</b>
<b>Using The Bass Extender</b> .....	<b>16</b>
<b>Final System Checks</b> .....	<b>17</b>
<b>Troubleshooting</b> .....	<b>17</b>
<b>Everyone Wants "More Bass"</b> .....	<b>19</b>
<b>Specifications</b> .....	<b>20</b>

## DESCRIPTION

The Clarion APA5241 5-channel car audio amplifier (shown in Figure 1) has a unique circuit topology that provides an additional summed output (on channel 5) to drive one or two subwoofers. The built-in mode switch provides convenient design flexibility so you can quickly configure a 3-, 4-, or 5-channel system with a flip of a switch. For 4-ohm loads, the APA5241 delivers 35 watts of continuous (rms) power on channels 1 through 4 and 100 watts of continuous (rms) power on channel 5.

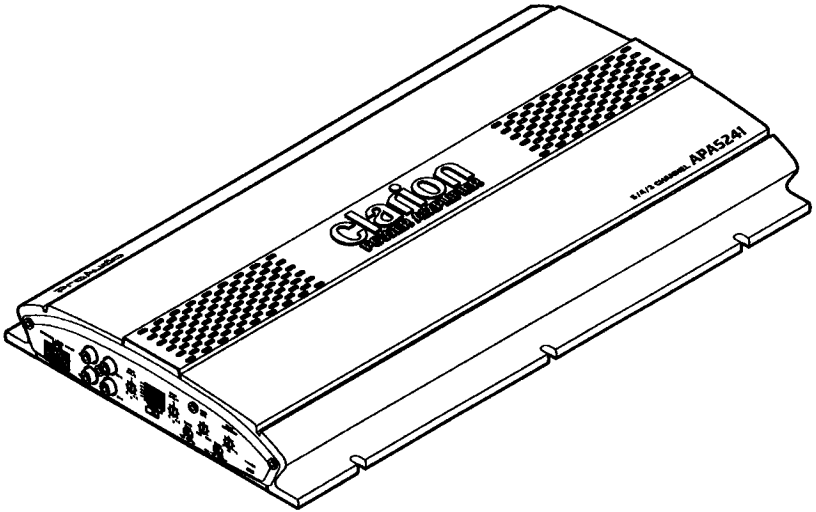

Figure 1. Clarion APA5241 5-channel car audio amplifier.

The built-in 12 dB-per-octave electronic high-pass/low-pass crossovers let you tailor the sound of all channels with selectable frequencies at 80, 120, or 180 Hz. Alternately, channels 1 through 4 can be set to pass all frequencies with channel 5 configured for low-pass filtering. With this built-in feature you don't need to add external crossovers and cables, resulting in a cost-effective, efficient way to implement your design ideas.

The APA5241 uses a regulated MOSFET power supply for superior control of output wattage, regardless of input voltage or musical energy content. MOSFETs are chosen for their inherent characteristics to provide superior accuracy, stability, and control. A toroid-coil transformer yields maximum power transfer with minimum heat loss. Careful attention to

circuit design keeps AM RFI at low levels, so you won't hear unwanted noise when the level is cranked up. Protection circuits safeguard the amplifier when overheating and speaker shorts or improper load conditions occur. All connections and controls are on end panels and are straightforward and easy to understand. We use gold-plated RCA and barrier connectors to ensure the best electrical connection for your system. Included are external automotive-type fuses that are easy to replace.

## **Amplifier Inputs/Controls/Power Indicator**

The APA5241's front panel (see Figure 2) has SPEAKER LEVEL INPUT connections, 4-channel (RCA) INPUT jacks, GAIN controls for 4-channel input level adjustments and summed input adjustment for channel 5, a BASS EXTENDER gain control, a CHANNEL mode switch, a FILTER FREQ control for selecting crossover filter frequencies, a FILTER mode switch, and a POWER indicator.

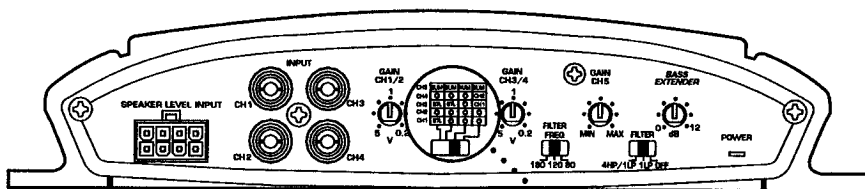
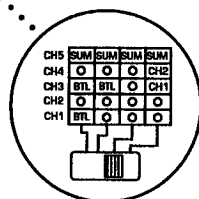

Figure 2. Front panel layout of the Clarion APA5241. A reference chart (see detail on right) shows which inputs are active for a selected channel mode.



## **Low-Level/Speaker-Level Inputs**

The APA5241's gold-plated RCA input jacks, labeled CH 1 through CH 4, provide connections for a low-level front/rear stereo source. Alternately, the SPEAKER LEVEL INPUT connections can be used in installation where the source unit's RCA outputs are unavailable and direct connection to speaker outputs is the only choice (see page 20 for wire codes).

## **Gain Controls**

The GAIN CH1/2 and GAIN CH3/4 controls allows you to independently set the nominal operating levels of the amplifier's front and rear channels. The GAIN CH5 control allows you to independently set the summed input

gain for channel 5. The amplifier's wide range, 200 mV to 5 V for RCA inputs or 400 mV to 10 V for speaker-level inputs, can accommodate input levels from virtually any brand of source unit.

### **High-Pass/Low-Pass Filter Controls**

The APA5241 is equipped with 12 dB-per-octave electronic filters for precise frequency attenuation with minimal phase distortion. When activated, the steep crossover slope keeps midrange tones out of the subwoofer connected to channel 5 and thereby eliminates an unnatural "nasal" tone quality in the audio system. The filters are activated by sliding the FILTER switch to either 1LP for low-pass filtering on channel 5 or 4HP/1LP which adds high-pass filtering on channels 1 through 4. Crossover points can be set at 80, 120, or 180 Hz via the FILTER FREQ switch. Use this feature, along with your speaker manufacturer's recommended crossover frequencies, to quickly design a more advanced system (see *Applications* starting on page 8).

*NOTE: If FILTER is set to OFF, changing the FILTER FREQ switch will produce no effect.*

### **Bass Extender Control**

The APA5241 also features a "low-Q" (i.e., wide frequency band) BASS EXTENDER circuit on channel 5 and is active in all modes of operation. It acts much like an equalizer, with adjustable gain (from 0 to +12 dB) fixed at 45 Hz. Use this feature to tune low-frequency audio response to compensate for a less-than-ideal subwoofer enclosure design. The added boost produces rich, full bass tones that are normally difficult to reproduce in the car audio environment.

*NOTE: If bass extension is undesired, set BASS EXTENDER to 0 dB.*

### **Channel Mode Switch**

The CHANNEL mode switch allows you to select 3-, 4-, or 5-channel operation, with the latter offering a choice of 4- or 2-channel inputs (on RCA or SPEAKER LEVEL connections) without having to use external "Y" adapters. A reference chart above the switch (see Figure 3 on the next page) indicates how the channel inputs are configured for your selection.

## 2-, 3-, 4-Channel Input Configurations

### FRONT PANEL SETTINGS

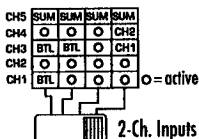

### FRONT PANEL SETTINGS

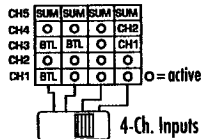

#### 2-Ch. Source Unit



Works with speaker or RCA Inputs

APA5241 Front Panel

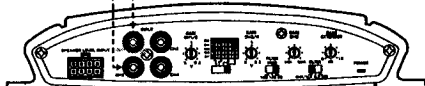

5-Ch. Output Configurations (see pages 8 and 9)

#### 4-Ch. Source Unit



Works with speaker or RCA Inputs

APA5241 Front Panel

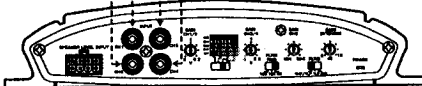

5-Ch. Output Configurations (see pages 8 and 9)

### FRONT PANEL SETTINGS

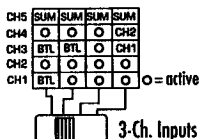

### FRONT PANEL SETTINGS

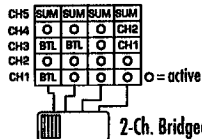

#### External X-over Unit

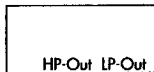

HP/LP crossed over approx. 600-800 Hz (creates Bridged Mid Bass application)

APA5241 Front Panel

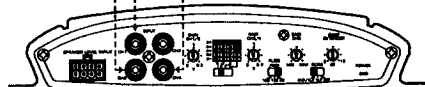

4-Channel Output Configuration

#### 2-Ch. Source Unit



Works with speaker or RCA Inputs

APA5241 Front Panel

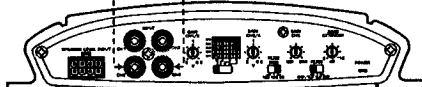

3-Ch. Output Configurations (see pages 10 and 11)

Figure 3. 2-, 3-, or 4-channel input configurations for the Clarion APA5241.

## Connections for Speakers/Power

The APA5241's rear panel (see Figure 4) contains speaker and power connection and external fuses

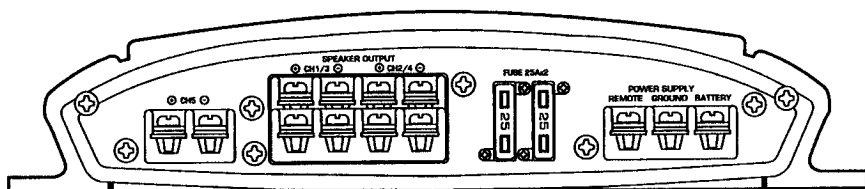

Figure 4. Rear panel layout of the Clarion APA5241.

### Speaker Connections

The speaker terminals are gold-plated terminals and are labeled as CH1 (left) and CH2 (right) for the upper row of connections and CH3 (left) and CH4 (right) for the bottom row. Connections for CH5 are on a separate pair of terminals

### Power Connections

The power connections are also gold-plated and are labeled REMOTE (for remote turn-on via source unit), GROUND, and BATTERY (+12 Vdc). A pair of automotive-type 25 A fuses protect the amplifier circuits.



# APPLICATIONS

The Clarion APA5241 5-channel car audio amplifier can be used in a variety of system applications. We've enclosed four example systems to help plan your own installation (see Figures 5 through 8).

## 5-Channel Full-Range Stereo System

### FRONT PANEL SETTINGS

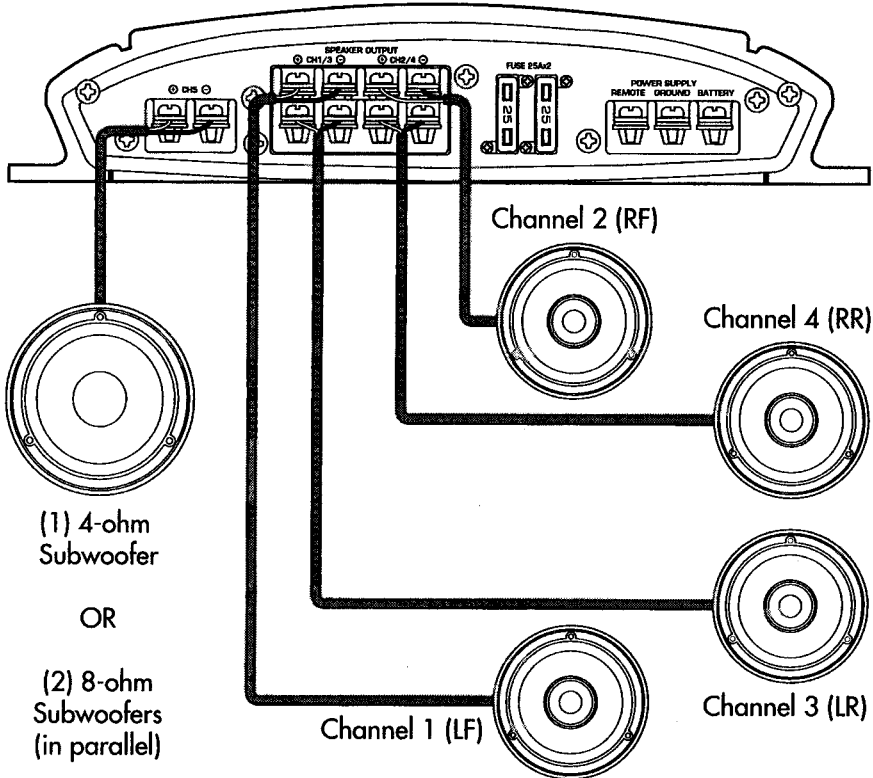
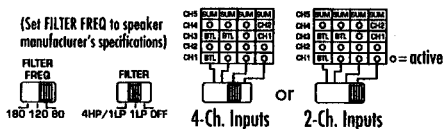

Figure 5. In this 5-channel system, an APA5241 drives two pairs of stereo full-range speakers for the front and the rear. The APA5241 also drives a single 4-ohm subwoofer (or a pair of 8-ohm subwoofers in parallel).

# 5-Channel Satellite Stereo System

## FRONT PANEL SETTINGS

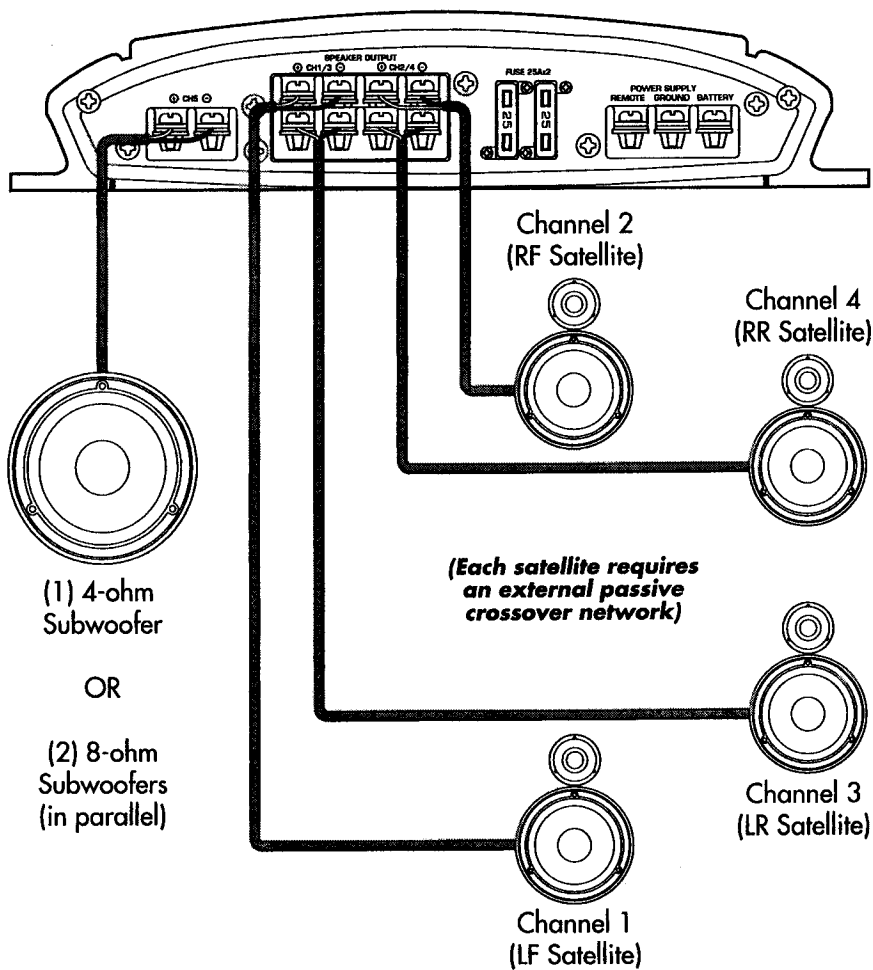
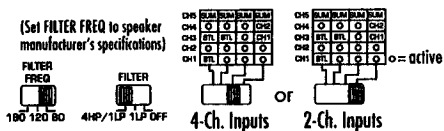
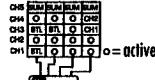

Figure 6. In this 5-channel system, an APA5241 drives two pairs of stereo satellite speakers for the front and the rear. The APA5241 also drives a single 4-ohm subwoofer (or a pair of 8-ohm subwoofers in parallel).

# 3-Channel Full-Range Stereo System

## FRONT PANEL SETTINGS

(Set FILTER FREQ to speaker manufacturer's specifications)



2-Ch. Bridged Inputs

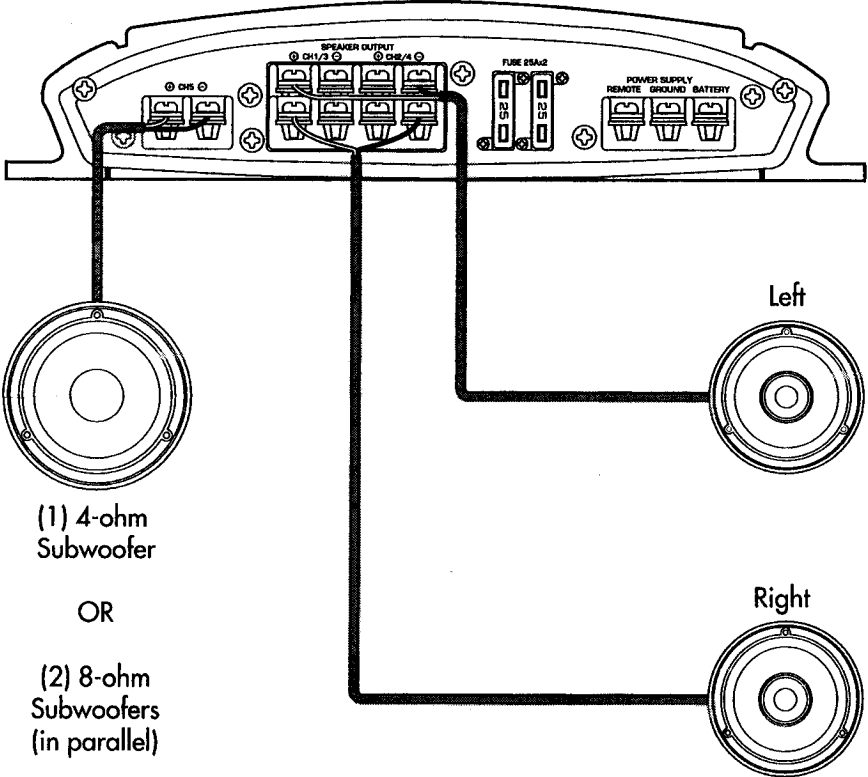

(1) 4-ohm Subwoofer

OR

(2) 8-ohm Subwoofers (in parallel)

Figure 7. In this application, the APA5241 is used as a 3-channel amplifier that drives two full-range stereo speakers at 90 watts per channel. The APA5241 also drives a single 4-ohm subwoofer or a pair of 8-ohm subwoofers in parallel.

# 3-Channel Satellite Stereo System

## FRONT PANEL SETTINGS

(Set FILTER FREQ to speaker manufacturer's specifications)

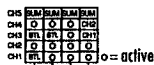

2-Ch. Bridged Inputs

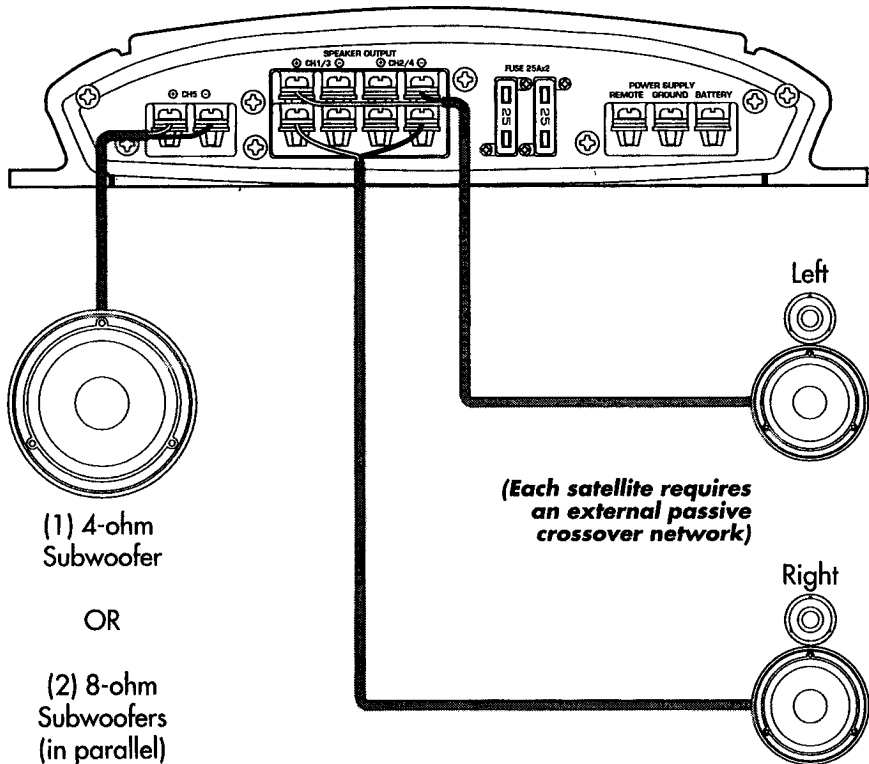

Figure 8. In this application, the APA5241 is used as a 3-channel amplifier that drives two sets of satellite speakers in stereo at 90 watts per channel. The APA5241 also drives a single 4-ohm subwoofer or a pair of 8-ohm subwoofers in parallel.

## **INSTALLATION**

This section lists mounting and wiring precautions for installing a Clarion APA5241 5-channel car audio amplifier. Combined with the experience of a professional installer, these safeguards provide enough detail to successfully complete an installation. If you do not have the necessary skills, do not install the amplifier yourself. Instead, see your authorized Clarion dealer for installation recommendations.

### **Mounting Precautions**

Although the Clarion APA5241 5-channel car audio amplifier incorporates an internal cooling fan and electronic protection circuits, mounting any amplifier in a confined space without any air movement or blocking the air intake or exhaust ports can still damage internal circuits over time. Choose a site that provides adequate ventilation around the amplifier. For easy system set up, mount the amplifier so the controls on the front panel will be accessible after installation.

In addition, observe these precautions:

- ◆ For the most efficient cooling, mount the amplifier so cool air runs along the length of the heatsink, rather than across it. Remember, any moving air across the heatsink surface will dissipate heat.
- ◆ Mount the amplifier on a rigid surface inside the vehicle. Do not install the amplifier on plastic or other combustible materials.
- ◆ Prior to drilling, make sure proposed mounting holes will not cut into the fuel tank, fuel lines, brake lines (under chassis), or electrical wiring.

### **Wiring Precautions**

- ◆ Read all wiring precautions. If you are not sure of the connections, contact your authorized Clarion dealer.
- ◆ Before installation, make sure the source unit power switch is in the OFF position.
- ◆ Disconnect the negative (–) lead at the battery before making any power connections.

- ◆ When making connections, be sure that each connection is clean and secure. Insulate final connections with electrical tape or shrink tubing. Failure to do so may damage your equipment.
- ◆ A secure, clean ground connection is critical to the performance of your Clarion car audio amplifier. Use the shortest ground wire possible to minimize resistance and avoid noise problems.
- ◆ Use the power cable calculator chart (see Figure 9 below) to determine the appropriate wire size for the amplifier's positive (+) power lead and the same-gauge black-insulated wire for the ground. Refer to Figure 10 (on the next page) when making electrical connections. Connect the amplifier's positive (+) power lead via a fuse directly to the positive (+) terminal on the battery. Do not connect this wire to the car's fuse panel.
- ◆ Add an external fuse on the positive (+) power lead and connect it as close as possible to the vehicle's (+) battery terminal. Use a rating that equals the total current consumption at full output of all amplifiers in the system. Adding an external fuse will protect the electrical system from short circuits that can cause a fire.
- ◆ Never ground the speakers to the vehicle chassis or body.

## **Power Cable Calculator**

Total System Amperage Draw	Cable 0' - 4'	Cable 4' - 7'	Cable 7' - 10'	Cable 10' - 13'	Cable 13' - 16'	Cable 16' - 19'	Cable 19' - 22'	Cable 22' - 28'
0 - 20 amperes	14	12	12	10	10	8	8	8
20 - 35 amperes	12	10	8	8	6	6	6	4
35 - 50 amperes	10	8	8	6	6	4	4	4
50 - 65 amperes	8	8	6	4	4	4	4	2
65 - 85 amperes	6	6	4	4	2	2	2	0
85 - 105 amperes	6	6	4	2	2	2	2	0
105 - 125 amperes	4	4	4	2	2	0	0	0
125 - 150 amperes	2	2	2	2	0	0	0	00

*Figure 9. Use this chart to find a copper-wire gauge that will exhibit no more than a 0.5 volt drop for a desired cable length. If aluminum or tinned wire is used, select an even larger gauge size to compensate for material difference. NOTE: Cable-size calculations take into account terminal connection resistance.*

# INSTALLATION

## Wiring Precautions (Continued)

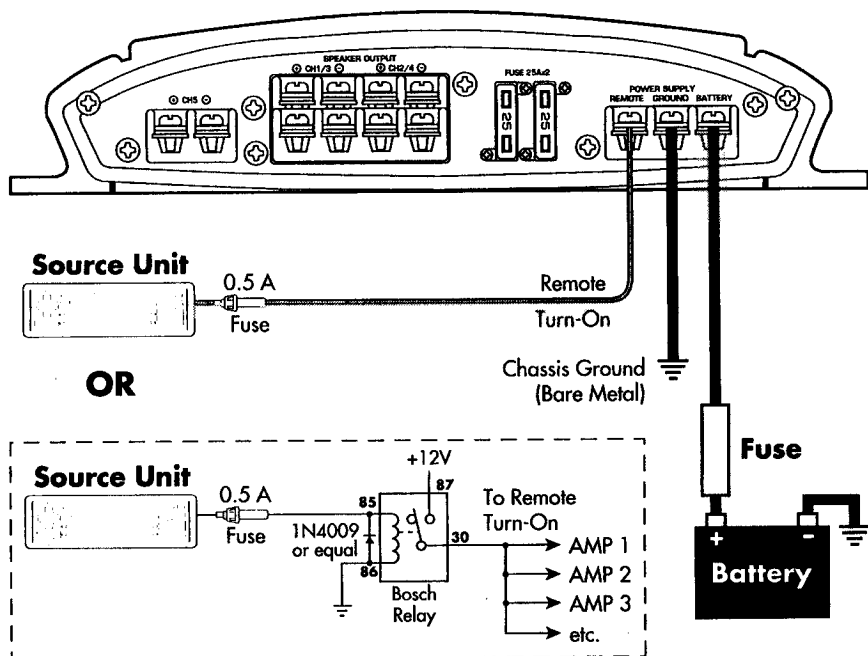

**Caution:** Clarion's Antenna/Amp output is restricted to 500 mA (MAXIMUM). Do not replace the 0.5A fuse with a higher value or you will damage the unit. If more current is required when installing multiple amplifiers, use this relay circuit.

Figure 10. Electrical connections for an APA5241 amplifier.

- ◆ When replacing any of the amplifier's fuses, always use one having the same current rating. Substituting a higher-rated fuse can reduce protection and may result in serious damage to the amplifier.
- ◆ Make sure that your vehicle's electrical system (i.e., alternator, battery, etc.) is capable of handling the additional load. If you are planning a multi-amplifier system, you may need to add a second battery and possibly upgrade the alternator with a higher-output-rated model. Consult your authorized Clarion dealer for recommendations.

- ◆ To avoid possible noise problems, run the amplifier's positive (+) power lead along one side of the vehicle to the battery. Run the remote turn-on wire and RCA audio cables down the center, and route the speaker wires along the remaining side. If wires must cross, run them perpendicular to each other.
- ◆ When creating passage holes for the power wire, use grommets to eliminate any sharp edges created during drilling. This will protect the wire from being nicked and causing a short circuit.
- ◆ Extra cable can cause signal loss and act as an "antenna" for noise. Use only high-quality RCA cables that are no longer than necessary to make a direct connection with the source unit or equalizer.
- ◆ Depending on the type of system being installed, refer to the examples in Figures 5 through 8 (starting on page 8) for information on wiring and setting the operation mode.

## SETTING GAIN

1. Turn all GAIN controls to their minimum (far left) positions. Also set BASS EXTENDER to 0 dB, and slide the FILTER switch to OFF.
2. Turn the vehicle's ignition switch to the ON position. Then turn the ON/OFF switch on the source unit to the ON position. Set all tone or equalization controls to "flat" positions and turn loudness off.
3. Play a CD or tape and set the volume control at 75% of full level.
4. Verify that the POWER indicator on the amplifier comes on.

*NOTE: When using an equalizer, set its frequency controls to "flat."*

5. Set the fader control (on the source unit) to full front and slowly increase the GAIN CH1/2 control for the front amplifiers (channels 1 and 2). Stop when you hear a slight distortion of audio. Set the fader to full rear and repeat this step for the rear amplifier using the GAIN CH 3/4 control.



## **USING THE HP/LP FILTER**

*NOTE: Clarion recommends turning the amplifier off before changing any switch position to eliminate any possible damage from transient spikes to the amplifier or speaker system.*

1. Depending on your application, slide the FILTER switch to the 4HP/1LP, 1LP, or OFF position.

*NOTE: The low-pass filter works only on channel 5's audio signals. If your application does not require a high-pass or low-pass filter, slide the FILTER switch to OFF.*

2. Slide the FILTER FREQ switch to a setting that is closest to the recommended crossover points from the speaker manufacturer.
3. Listen to a variety of music styles (Rock, Rap, etc.) and try different FILTER FREQ settings until the best performance is realized.

## **USING THE BASS EXTENDER**

1. Initially set the BASS EXTENDER control to its full left position (i.e., 0 dB).
2. Listen to a variety of music styles (e.g., Rock, Rap, etc.) and slowly increase the BASS EXTENDER control until a noticeable increase in low bass response is perceived.
3. Slowly adjust the BASS EXTENDER gain control (up or down) to realize the best bass response.

*CAUTION: If you hear a "pop" (due to speaker over-excursion), lower the BASS EXTENDER to prevent speaker damage. If the system sounds muddy and distorted (due to amplifier clipping), lower BASS EXTENDER to avoid shutdown from overheating.*

## FINAL SYSTEM CHECKS

1. Start the engine and turn on the source unit. After a two-second delay, slowly increase the volume control and listen to the audio. If you hear any noise, static, distortion, or no sound at all, check the connections, and also refer to *Troubleshooting*. Depending on your system, the levels may be quite loud even at low volume settings. Until you get an “audio feel” of the system’s power, use care when adjusting controls.
2. Vary the balance control from left to right and listen to the results. Bass levels should not vary, since the inputs are internally summed.

*NOTE: When using 2-channel inputs, set the amplifier’s front/rear balance via the GAIN CH1/2 and GAIN CH3/4 controls.*

3. Increase the volume and verify that the amplifier reproduces audio without distortion. If you hear distortion, check the connections and verify that the amplifier gain and BASS EXTENDER controls are set correctly. Another possibility is damaged (or under-powered) speakers. Once again, refer to *Troubleshooting* for additional help.

## TROUBLESHOOTING

<b>Symptom</b>	<b>Cause</b>	<b>Solution</b>
No audio	Low or no remote turn-on voltage	Check REMOTE wiring or add relay if source unit fuse continues to blow
	Blown amplifier fuse	Replace with new fast-blow fuse (same rating)
	Power wires not connected	Check BATTERY and GROUND wiring at amplifier; check battery connections
	Speaker leads shorted	Check speaker continuity to ground; should not show a common ground

## TROUBLESHOOTING (CONT'D)

<b>Symptom</b>	<b>Cause</b>	<b>Solution</b>
No audio	Low or no remote Speakers not connected or are blown	Check REMOTE wiring Check speaker connections at amplifier; measure coil impedance
Audio cycles on and off	Thermal protection circuits are shutting amplifier off	Check location for adequate ventilation; consult an authorized Clarion dealer
Distorted audio	Gain is not set properly, or damaged speaker cones	Review <i>Setting Gain</i> on page 15; inspect each speaker cone for signs of damage (e.g., frozen cone, burning smell, etc.)
Audio lacks punch	Speakers wired incorrectly, which causes cancellation of bass frequencies	Check polarity of wires from amplifier to each speaker as defined by the system design
Amplifier fuse keeps blowing	Incorrect wiring or short circuit	Review <i>Installation</i> on page 12 and check all wiring connections
Whining or ticking noise in the audio with engine on	Amplifier is picking up alternator noise or radiated noise	Check power and ground connections on amplifier; check or move audio cables; install an in-line noise filter on source unit's power wire; check alternator and/or voltage regulator; test for weak battery or add water to battery

## **EVERYONE WANTS "MORE BASS"**

In the car audio environment, subsonic bass information (often called "thump") requires three sizable components:

1. Speaker Piston Area (the size of the moving surface)
2. Cone Excursion (the amount of surface travel)
3. Power (the ability to move the surface)

In a home, bass is easily propagated (i.e., reproduce one complete cycle of an audio signal), whereas in a small vehicle, "air pressure" must be modulated to simulate propagation of the bass wave. Speaker piston area and cone excursion become the critical factors in producing low-frequency response.

As a general rule of thumb, remember that the smaller the speaker, the greater the mechanical cone travel required to produce low bass. The larger the speaker, the shorter the mechanical cone travel required to produce the same bass response.

A single subwoofer can only produce as much "pressure" as the piston area and the amount of mechanical cone excursion allow. Throwing more power on a single subwoofer may not be the best answer to more bass response. Adding multiple subwoofers to an audio system is often more economical than adding sheer brute amplifier power.

The best answer may be a combination of factors, including larger speakers, multiple drivers, and bigger amplifiers. This may require modification of the car's electrical system, or special installation skills necessary to design and install multiple subwoofer speaker systems. Just how much bass is enough?

Everyone wants "more BASS" in the car audio environment. If this is your goal, we suggest visiting your local authorized Clarion dealer for professional system designs and installation options.

# SPECIFICATIONS

## APA5241 5-Channel Power Amplifier

Maximum Power Output:	550 watts (90 watts x 4 + 230 W x 1)
Continuous Average Power Output: (Channels 1 through 4)	35 watts x 4 into 4 ohms; 20 Hz to 20 kHz, 0.04% THD  90 watts x 2 into 4 ohms (bridged); 20 Hz to 20 kHz, 0.4% THD
Continuous Average Power Output: (Channel 5)	100 watts x 1 into 4 ohms (typical); 20 Hz to 20 kHz, 0.04% THD
Frequency Response ( $\pm 1$ dB):	10 Hz to 50 kHz
Signal-to-Noise Ratio (A-wtd):	100 dB or better
Input Sensitivity (at rated output):	Low-Level (RCA): 200 mV to 5 V Speaker-Level: 400 mV to 10 V
Current Use (at rated output):	< 45 amps
Speaker Load Capacity:	2 ohms stereo, channels 1 to 4 4 ohms mono, channel 5
Dimensions (W x H x L):	9 1/16" x 1 7/8" x 15 3/4" 230 mm x 47.5 mm x 400 mm

## APA5241 Speaker-Level Wire Codes

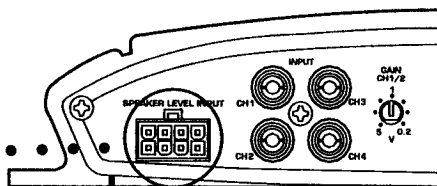
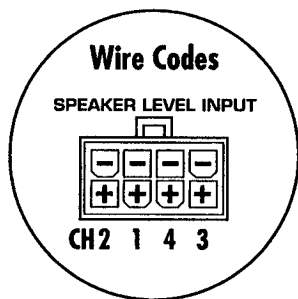

**APA5241 Front**